

1/8" & 1/4" Threaded Nipples and Lengths

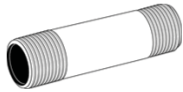

No.	Description	Each
BLP18X2	1/8" x 2" Nipple	\$1.36
BLP14XCL	1/4" x Close Nipple	\$1.32

1/2" Threaded Nipples and Lengths

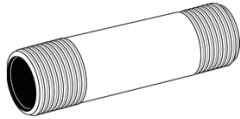

No.	Description	Each
BLP12XCL	1/2" x Close Nipple	\$1.30
BLP12X2	1/2" x 2" Nipple	\$1.30
BLP12X212	1/2" x 2-1/2" Nipple	\$1.32
BLP12X3	1/2" x 3" Nipple	\$1.36
BLP12X312	1/2" x 3-1/2" Nipple	\$1.58
BLP12X4	1/2" x 4" Nipple	\$1.84
BLP12X412	1/2" x 4-1/2" Nipple	\$1.86
BLP12X5	1/2" x 5" Nipple	\$1.92
BLP12X512	1/2" x 5-1/2" Nipple	\$2.08
BLP12X6	1/2" x 6" Nipple	\$2.16
BLP12X8	1/2" x 8" Nipple	\$4.28
BLP12X10	1/2" x 10" Nipple	\$5.16
BLP12X11	1/2" x 11" Nipple	\$5.28
BLP12X12	1/2" x 12" Nipple	\$6.10
BLP12X18	1/2" x 18" Nipple	\$10.76
BLP12X24	1/2" x 24" Nipple	\$12.46
BLP12X36	1/2" x 36" Nipple	\$15.84
BLP12X48	1/2" x 48" Nipple	\$21.78
BLP12X60	1/2" x 60" Nipple	\$26.14
BLP12X120	1/2" x 120" Nipple	\$26.68

3/4" Threaded Nipples and Lengths

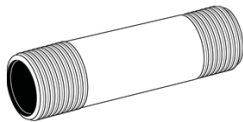

No.	Description	Each
BLP34XCL	3/4" x Close Nipple	\$1.32
BLP34X112	3/4" x 1-1/2" Nipple	\$1.36
BLP34X2	3/4" x 2" Nipple	\$1.40
BLP34X212	3/4" x 2-1/2" Nipple	\$1.54
BLP34X3	3/4" x 3" Nipple	\$1.60
BLP34X312	3/4" x 3-1/2" Nipple	\$1.94
BLP34X4	3/4" x 4" Nipple	\$2.00
BLP34X412	3/4" x 4-1/2" Nipple	\$2.40
BLP34X5	3/4" x 5" Nipple	\$2.76
BLP34X512	3/4" x 5-1/2" Nipple	\$2.74
BLP34X6	3/4" x 6" Nipple	\$2.84
BLP34X7	3/4" x 7" Nipple	\$4.54
BLP34X8	3/4" x 8" Nipple	\$4.72
BLP34X10	3/4" x 10" Nipple	\$5.72
BLP34X11	3/4" x 11" Nipple	\$5.90
BLP34X12	3/4" x 12" Nipple	\$6.12
BLP34X18	3/4" x 18" Nipple	\$10.60
BLP34X24	3/4" x 24" Nipple	\$13.60
BLP34X36	3/4" x 36" Nipple	\$18.84
BLP34X60	3/4" x 60" Nipple	\$30.68
BLP34X72	3/4" x 72" Nipple	\$28.92
BLP34X120	3/4" x 120" Nipple	\$35.02

1" Threaded Nipples and Lengths

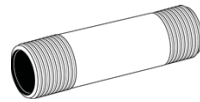

No.	Description	Each
BLP1XCL	1" x Close Nipple	\$1.86
BLP1X2	1" x 2" Nipple	\$2.12
BLP1X212	1" x 2-1/2" Nipple	\$2.16
BLP1X3	1" x 3" Nipple	\$2.24
BLP1X312	1" x 3-1/2" Nipple	\$2.76
BLP1X4	1" x 4" Nipple	\$2.76
BLP1X412	1" x 4-1/2" Nipple	\$3.16
BLP1X5	1" x 5" Nipple	\$1.58
BLP1X512	1" x 5-1/2" Nipple	\$3.70
BLP1X6	1" x 6" Nipple	\$3.70
BLP1X7	1" x 7" Nipple	\$6.04
BLP1X8	1" x 8" Nipple	\$6.08
BLP1X9	1" x 9" Nipple	\$7.08
BLP1X10	1" x 10" Nipple	\$7.08
BLP1X11	1" x 11" Nipple	\$8.16
BLP1X12	1" x 12" Nipple	\$28.32
BLP1X18	1" x 18" Nipple	\$13.12
BLP1X24	1" x 24" Nipple	\$17.20
BLP1X30	1" x 30" Nipple	\$19.82
BLP1X36	1" x 36" Nipple	\$23.90
BLP1X48	1" x 48" Nipple	\$31.20
BLP1X120	1" x 120" Nipple	\$52.44

1-1/4" Threaded Nipples and Lengths

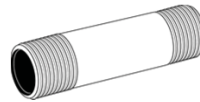

No.	Description	Each
BLP114XCL	1-1/4" x Close Nipple	\$2.44
BLP114X2	1-1/4" x 2" Nipple	\$3.08
BLP114X212	1-1/4" x 2-1/2" Nipple	\$3.26
BLP114X3	1-1/4" x 3" Nipple	\$3.66
BLP114X4	1-1/4" x 4" Nipple	\$3.44
BLP114X412	1-1/4" x 4-1/2" Nipple	\$3.98
BLP114X5	1-1/4" x 5" Nipple	\$4.12
BLP114X512	1-1/4" x 5-1/2" Nipple	\$4.74
BLP114X6	1-1/4" x 6" Nipple	\$4.92
BLP114X7	1-1/4" x 7" Nipple	\$7.92
BLP114X8	1-1/4" x 8" Nipple	\$7.92
BLP114X9	1-1/4" x 9" Nipple	\$9.48
BLP114X10	1-1/4" x 10" Nipple	\$10.54
BLP114X11	1-1/4" x 11" Nipple	\$11.96
BLP114X12	1-1/4" x 12" Nipple	\$11.96
BLP114X18	1-1/4" x 18" Nipple	\$19.30
BLP114X24	1-1/4" x 24" Nipple	\$22.50
BLP114X30	1-1/4" x 30" Nipple	\$21.78
BLP114X36	1-1/4" x 36" Nipple	\$32.60
BLP114X48	1-1/4" x 48" Nipple	\$41.50
BLP114X120	1-1/4" x 120" Nipple	\$66.56

Nipple Tray

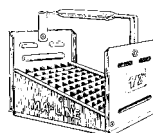

No.	Description	Each
BLP12TRAY	1/2" Nipple Tray	\$70.32
BLP34TRAY	3/4" Nipple Tray	\$76.46
BLP1"TRAY	1" Nipple Tray	\$89.24

1-1/2" Threaded Nipples and Lengths

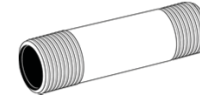

No.	Description	Each
BLP112XCL	1-1/2" x Close Nipple	\$3.38
BLP112X2	1-1/2" x 2" Nipple	\$4.06
BLP112X212	1-1/2" x 2-1/2" Nipple	\$4.56
BLP112X3	1-1/2" x 3" Nipple	\$4.56
BLP112X4	1-1/2" x 4" Nipple	\$5.10
BLP112X5	1-1/2" x 5" Nipple	\$6.26
BLP112X12	1-1/2" x 12" Nipple	\$15.30
BLP112X60	1-1/2" x 60" Nipple	\$64.24

2" Threaded Nipples and Lengths

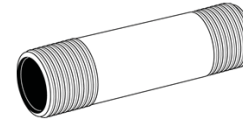

No.	Description	Each
BLP2XCL	2" x Close Nipple	\$4.58
BLP2X3	2" x 3" Nipple	\$5.26
BLP2X312	2" x 3-1/2" Nipple	\$6.36
BLP2X4	2" x 4" Nipple	\$6.36
BLP2X7	2" x 7" Nipple	\$14.36
BLP2X8	2" x 8" Nipple	\$12.92
BLP2X9	2" x 9" Nipple	\$15.20
BLP2X10	2" x 10" Nipple	\$21.72
BLP2X11	2" x 11" Nipple	\$24.98
BLP2X12	2" x 12" Nipple	\$17.48
BLP2X18	2" x 18" Nipple	\$25.14
BLP2X24	2" x 24" Nipple	\$36.64
BLP2X120	2" x 120" Nipple	\$104.64

Dryer Connector

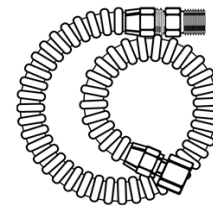

No.	Description	Each
CON1136SS	1/2" x 36" Dryer Bulk	\$20.22
CON1148SS	1/2" x 48" Dryer Bulk	\$28.84
CON1160SS	1/2" x 60" Dryer Bulk	\$32.22

Gas Connector Stainless Steel

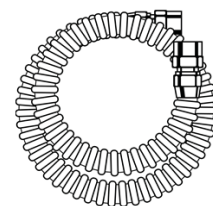

No.	Description	Each
CON5091124SS	1/2"OD x 24" Gas Conn.	\$21.92
CON5091560SS	1/2"OD x 60" Gas Conn.	\$36.76



45 Degree Elbows



No.	Description	Each
BLPE4512	1/2" 45 Elbow	\$2.20
BLPE4534	3/4" 45 Elbow	\$2.82
BLPE45114	1-1/4" 45 Elbow	\$6.56
BLPE45112	1-1/2" 45 Elbow	\$8.98

45 Degree Street Elbows



No.	Description	Each
BLPSE4512	1/2" 45 Street Elbow	\$3.48
BLPSE4534	3/4" 45 Street Elbow	\$5.38

90 Degree Elbows

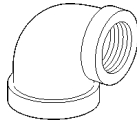

No.	Description	Each
BLPE9014	1/4" 90 Elbow	\$1.96
BLPE9012	1/2" 90 Elbow	\$1.36
BLPE9034	3/4" 90 Elbow	\$1.64
BLPE901	1" 90 Elbow	\$3.12
BLPE90114	1-1/4" 90 Elbow	\$5.08
BLPE90112	1-1/2" 90 Elbow	\$6.68
BLPE902	2" 90 Elbow	\$11.48

90 Degree Reducing Elbow

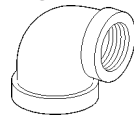

No.	Description	Each
BLPRE3412	3/4" x 1/2"	\$3.12
BLPRE11434	1-1/4" x 3/4"	\$7.34
BLPRE1141	1-1/4" x 1"	\$5.58
BLPRE112114	1-1/2" x 1-1/4"	\$10.58
BLPRE2114	2" x 1-1/4"	\$15.44

90 Degree Street Elbows

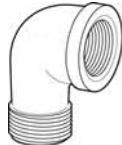

No.	Description	Each
BLPSE9012	1/2" 90 Street Elbow	\$3.04
BLPSE9034	3/4" 90 Street Elbow	\$3.00
BLPSE9012	1" 90 Street Elbow	\$3.04

Caps



No.	Description	Each
BLPCA12	1/2" Cap	\$1.36
BLPCA34	3/4" Cap	\$1.82
BLPCA1	1" Cap	\$2.32
BLPCA114	1-1/4" Cap	\$3.16
BLPCA2	2" Cap	\$6.24

Reducing Couplings

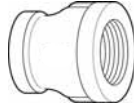

No.	Description	Each
BLPRC1238	1/2" x 3/8" Re Cplg	\$2.28
BLPRC3418	3/4" x 1/8" Re Cplg	\$3.96
BLPRC3412	3/4" x 1/2" Re Cplg	\$2.36
BLPRC112	1" x 1/2" Re Cplg	\$4.06
BLPRC11434	1-1/4" x 3/4" Re Cplg	\$5.08
BLPRC1141	1-1/4" x 1" Re Cplg	\$5.08
BLPRC1121	1-1/2" x 1" Re Cplg	\$7.44
BLPRC112114	1-1/2" x 1-1/4" Re Cplg	\$6.40
BLPRC134	1" x 3/4" Re Cplg	\$4.06
BLPRC2112	2" x 1-1/2" Re Cplg	\$9.34
BLPRC2114	2" x 1-1/4" Re Cplg	\$10.68
BLPRC234	2" x 3/4" Re Cplg	\$10.68
BLPRC32	3" x 2" Re Cplg	\$30.72

Couplings



No.	Description	Each
BLPCO12	1/2" Coupling	\$1.82
BLPCO34	3/4" Coupling	\$2.64
BLPCO1	1" Coupling	\$3.96
BLPCO112	1-1/2" Coupling	\$6.76
BLPCO114	1-1/4" Coupling	\$5.08
BLPCO2	2" Coupling	\$9.98

Unions

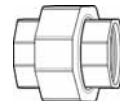

No.	Description	Each
BLPU12	1/2" Union	\$6.52
BLPU34	3/4" Union	\$7.76
BLPU1	1" Union	\$9.24
BLPU114	1-1/4" Union	\$13.48
BLPU112	1-1/2" Union	\$14.96
BLPU2	2" Union	\$22.63

Plugs



No.	Description	Each
BLPPL18	1/8" Plug	\$1.60
BLPPL12	1/2" Plug	\$1.32
BLPPL34	3/4" Plug	\$1.32
BLPPL1	1" Plug	\$1.68
BLPPL114	1-1/4" Plug	\$2.22
BLPPL112	1-1/2" Plug	\$3.30
BLPPL2	2" Plug	\$4.72

Gas Ball Valve

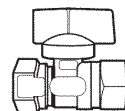

No.	Description	Each
22399	1/2" without handle	\$13.78
22397	1/2" with handle	\$8.36
22388	3/4" without handle	\$14.12
22398	3/4" with handle	\$11.88

Tees

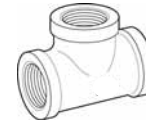

No.	Description	Each
BLPT12	1/2" Tee	\$1.76
BLPT34	3/4" Tee	\$2.48
BLPT1	1" Tee	\$4.80
BLPT114	1-1/4" Tee	\$7.10
BLPT112	1-1/2" Tee	\$10.80
BLPT2	2" Tee	\$15.00

Reducing Tees

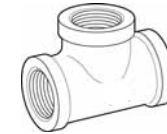

No.	Description	Branch	Each
BLPRT121234	1/2" x 1/2"	3/4"	\$4.80
BLPRT341234	3/4" x 1/2"	3/4"	\$4.80
BLPRT343412	3/4" x 3/4"	1/2"	\$4.20
BLPRT13434	1" x 3/4"	3/4"	\$5.64
BLPRT1134	1" x 1"	3/4"	\$5.96
BLPRT1112	1" x 1"	1-1/2"	\$5.96
BLPRT11211212	1-1/2" x 1-1/2"	1/2"	\$10.08
BLPRT11434114	1-1/4" x 3/4"	1-1/4"	\$10.80
BLPRT11411412	1-1/4" x 1-1/4"	1/2"	\$11.08
BLPRT11412114	1-1/4" x 1/2"	1-1/4"	\$8.52
BLPRT11411434	1-1/4" x 1-1/4"	3/4"	\$10.86
BLPRT2342	2" x 3/4"	2"	\$20.28
BLPRT212	2" x 1"	2"	\$22.98
BLPRT2212	2" x 2"	1/2"	\$16.84
BLPRT221	2" x 2"	1"	\$16.84
BLPRT22114	2" x 2"	1-1/4"	\$17.92
BLPRT22112	2" x 2"	1-1/2"	\$17.80

Reducing Bushing



No.	Description	Each
BLPB14X18	1/4" x 1/8" Re Bshng	\$5.28
BLPB1218	1/2" x 1/8" Re Bshng	\$5.28
BLPB3418	3/4" x 1/8" Re Bshng	\$3.26
BLPB3412	3/4" x 1/2" Re Bshng	\$2.40
BLPB1X12	1" x 1/2" Re Bshng	\$3.03
BLPB1X34	1" x 3/4" Re Bshng	\$3.06
BLPB114X12	1-1/4" x 1/2" Re Bshng	\$5.04
BLPB11434	1-1/4" x 3/4" Re Bshng	\$4.52
BLPB114X1	1-1/4" x 1" Re Bshng	\$4.52
BLPB112X12	1-1/2" x 1/2" Re Bshng	\$5.72
BLPB11234	1-1/2" x 3/4" Re Bshng	\$5.72
BLPB112114	1-1/2" x 1-1/4" Re Bshng	\$5.78
BLPB2114	2" x 1-1/4" Re Bshng	\$10.90
BLPB2X112	2" x 1-1/2" Re Bshng	\$6.70

Assortment Packages



No.	Description	Each
12XASST100	1/2" Nipple Pack	\$91.18
34XASST100	3/4" Nipple Pack	\$110.18
100XASST060	1" Nipple Pack	\$161.34

PVC FITTINGS



90 Degree Elbow



Part No.	Description	Each
22333	3/4" L	\$0.50
22372	2" L	\$2.74
22310	2-1/2" L	\$8.16
22312	3" L	\$10.82

90 Degree Long Radius

Part No.	Description	Each
22306	2" LR	\$6.04
22328	3" LR	\$14.20

90 Degree Street Elbow



Part No.	Description	Each
22329	3/4" Street L	\$1.54
22324	2" Street L	\$3.98
22318	3" Street L	\$11.98

90 Degree Elbow Long Radius

Part No.	Description	Each
22316	2" LR Street L	\$9.40
22317	3" LR Street L	\$25.82

45 Degree Elbow



Part No.	Description	Each
22337	3/4" 45L	\$1.16
22304	2" 45L	\$3.28
22309	2-1/2" 45L	\$8.16
22326	3" 45L	\$9.66

45 Degree Street Elbow



Part No.	Description	Each
22314	2" Street L	\$3.50
22315	3" Street L	\$9.48

Pipe Strap



Part No.	Description	Each
22335	3/4 Pipe Strap	\$0.50

J-Hook Pipe Holder



Drain Pipe Holder up to 3"
Bag of 25

Part No.	Description	Each
HDWJ3000	3" x 7-1/2" Holder	\$63.72

PVC Pipe

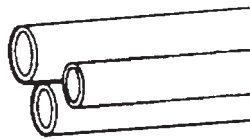

Part No.	Description	Each
22343	3/4" 10 ft	\$5.24
22300	2" 10 ft	\$19.59
22307	2-1/2" 10 ft	\$42.20
22320	3" 10 ft	\$45.16

Cellular Core Pipe

Part No.	Description	Each
22251	2" x 10ft	\$15.82
22252	3" x 10ft	\$33.18

Roof Flashing

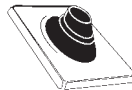

No.	Description	Each
FLSH142	1-1/2", 2", 3" Flashing	\$11.58

PVC Pipe Cutter

Cuts polyethylene, polybutylene, PVC, ABS and rubber hose; all sizes up to 1-1/2" OD.

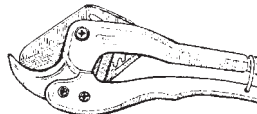

Clean cut eliminates, deburring and sawdust. Ideal in restricted work space, and can be carried in back pocket or tool pouch.

Part No.	Description	Each
22347	PVC Pipe Cutter	\$45.78

Tees

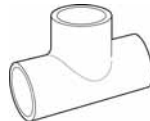

Part No.	Description	Each
22319	3/4"	\$0.66
22250	2"	\$2.84
22352	2-1/2"	\$11.16
22373	3"	\$13.98

Caps



Part No.	Description	Each
22284	3/4"	\$0.48
22281	2"	\$1.18
22378	2-1/2"	\$4.48
22379	3"	\$4.90

PVC Primer and Cement



Part No.	Description	Each
22344	4 oz Cement	\$6.62
22345	8 oz Cement	\$10.00
22353	8 oz Primer	\$7.86
22348	16 oz all weather cement	\$13.56

Couplings



Part No.	Description	Each
22321	3/4"	\$0.50
22302	2"	\$1.50
22313	2-1/2"	\$3.54
22322	3"	\$7.80

Reducing Bushings

Part No.	Description	Each
22308	2-1/2" FTG x 2" SL	\$3.20
22287	3 FTG x 2" SL	\$4.74
22305	3 FTG x 2-1/2" SL	\$4.74

MPT Adapter

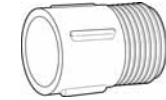

Part No.	Description	Each
22327	3/4" MPT x 3/4" SL	\$0.48

FPT Adapter

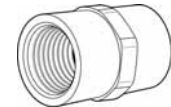

Part No.	Description	Each
22339	3/4" FPT x 3/4" SL	\$0.66

FPT 90 Degree Elbow

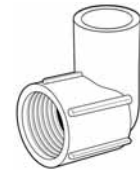

Part No.	Description	Each
22331	3/4" FPT x 3/4" L SL	\$0.60

MPT 90 Degree Elbow



Part No.	Description	Each
22341	3/4" MPT x 3/4" L SL	\$1.16

Running Trap



Part No.	Description	Each
22325	3/4" Run Trap	\$1.62

P Trap

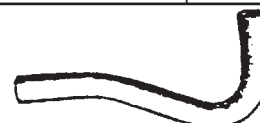

Part No.	Description	Each
22323	3/4" P Trap	\$1.62



Type "K" Tubing

For refrigeration, plumbing, heating and under-ground use. Heavy duty.

Sold in 10 ft. Lengths.

No.	OD	ID	Wall Type	Thick	Each
07000	3/8	1/4	K	.035	\$43.66
07001	1/2	3/8	K	.049	\$66.96
07002	5/8	1/2	K	.049	\$75.92
07003	3/4	5/8	K	.049	\$80.16
07004	7/8	3/4	K	.065	\$114.00
07005	1-1/8	1	K	.065	\$185.94
07006	1-3/8	1-1/4	K	.065	\$205.68
07007	1-5/8	1-1/2	K	.072	\$276.12
07008	2-1/8	2	K	.083	\$427.08
07009	2-5/8	2-1/2	K	.095	\$120.00

Type "L" or ACR Tubing

For interior plumbing and heating.

Sold in 10 ft. Lengths.

No.	OD	ID	Wall Type	Thick	Each
07020	3/8	1/4	L	.030	\$37.92
07021	1/2	3/8	L	.035	\$57.54
07022	5/8	1/2	L	.040	\$57.74
07023	3/4	5/8	L	.042	\$81.70
07024	7/8	3/4	L	.045	\$110.16
07025	1-1/8	1	L	.050	\$159.70
07026	1-3/8	1-1/4	L	.055	\$176.22
07027	1-5/8	1-1/2	L	.060	\$225.96
07028	2-1/8	2	L	.070	\$355.26

Type "M" Tubing

For hydronics and plumbing.

Sold in 10 ft. Lengths.

No.	OD	ID	Wall Type	Thick	Each
07042	5/8	1/2	M	.028	\$34.00
07044	7/8	3/4	M	.030	\$55.94
07045	1-1/8	1	M	.035	\$86.74
07046	1-3/8	1-1/4	M	.042	\$70.27
07047	1-5/8	1-1/2	M	.049	\$175.86

Soft Copper Tubing

Refrigeration Dehydrated and sealed soft copper.

Sold in 50 ft. Rolls.

No.	OD	ID	Wall Type	Thick	Each
08127	1/8		Ref	.030	\$59.70
08110	3/16		Ref	.030	\$80.08
08111	1/4		Ref	.030	\$85.06
08112	5/16		Ref	.032	\$107.70
08113	3/8	1/4	Ref	.032	\$129.18
08115	1/2	3/8	Ref	.032	\$171.12
08156	5/8	1/2	Ref	.035	\$218.80
08157	3/4	5/8	Ref	.035	\$279.18
08159	7/8	3/4	Ref	.045	\$392.64

Mueller Streamline Fast Cutting Sand Cloth

Mueller Brass Streamline fast cutting sand cloth is 1-1/2" wide with 120 aluminum oxide abrasive supplies in 3 different lengths. In small dispensing carton.

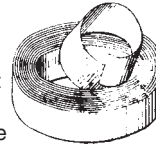

No.	Description	Each
32135	30 Ft. x 1-1/2"	\$7.12
32136	75 Ft. x 1-1/2"	\$22.98
32137	150 Ft. x 1-1/2"	\$19.04

Open Mesh Plumbers Roll

32145	1-1/2" x 10 Yards	\$15.72
-------	-------------------	---------

Mueller Scotch Brite Cleaning Pad

Fast cleaning pads that remove oxides from copper tubing prior to brazing or soldering, 1/4" thick 3" x 5". 10 pads in a box. Very abrasive. Sold only in boxes of 10.



No.	Description	Each
32139	Box of 10 pads	\$12.70

Polyethylene Black Cloth Dri-Cel Tape

Pressure sensitive waterproof polyethylene impregnated cotton back tape to match Dri-Cel insulation. Used in place of cement to join the Dri-Cel ends of tubing and seal out moisture.



No.	Width	Length	Each
29875	2"	60 Ft.	\$27.00

Insulation Adhesive

This quick setting synthetic rubber base contact adhesive is ready to use and makes a strong bond. Will cement Dri-Cel insulation or any rubber product, paper, cloth or wood to themselves, or each other, or to glass, metal or plastic. Surfaces must be clean of dust, powder, grease and oil to make a firm bond. Pint and 1/2 pint cans supplied with brush. Cannot ship pre-paid.



No.	Size	Each
64680	1/2 Pint	\$8.62
64682	1 Quart	\$20.94

Vibration Absorber



Made of flexible, seamless, corrugated, fitted with female copper tube ends.

- Bronze with Female Ends up to 1-3/8".
- Stainless Steel with Female End for 1-5/8" & 2-1/8".

No.	OD Tube	Overall	Each
03238	1/4	7-1/2"	\$35.20
03239	3/8	8-1/4	\$21.94
03200	1/2	9	\$44.80
03201	5/8	9-3/4	\$67.78
03202	3/4	11-1/4	\$35.36
03203	7/8	11-1/2	\$74.46
03204	1-1/8	13	\$103.70
03205	1-3/8	14-3/4	\$143.84
03206	1-5/8	17	\$216.10
03207	2-1/8	20	\$212.10

Pipe Insulation

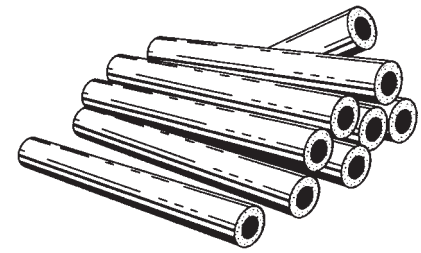

Wall thickness recommendations.

Line Temp	Air Temp	Relative Humidity	Use Wall
50 deg	85 deg	70 %	3/8
50 deg	85 deg	70 %	1/2
32 deg	85 deg	70 %	1/2
0 deg	85 deg	70 %	3/4
50 deg	90 deg	80 %	3/4
32 deg	90 deg	80 %	3/4

3/8 inch Wall

For OD size add 3/4 inch to inside diameter.

No.	ID	Wall	IPS	Ctn	Ea 6ft
64610	3/8	3/8	—	100	\$3.28
64611	1/2	3/8	1/4	80	\$4.24
64612	5/8	3/8	3/8	65	\$4.94
64613	3/4	3/8	—	55	\$5.16
64614	7/8	3/8	1/2	50	\$5.40
64616	1-1/8	3/8	—	35	\$6.08
64617	1-3/8	3/8	—	30	\$5.20
64618	1-5/8	3/8	—	20	\$7.54
64619	2-1/8	3/8	—	16	\$8.98

1/2 inch Wall

For OD size add 1 inch to inside diameter.

No.	ID	Wall	IPS	Ctn	Ea 6ft
64630	3/8	1/2	—	75	\$6.08
64631	1/2	1/2	1/4	66	\$4.40
64632	5/8	1/2	3/8	54	\$6.66
64633	3/4	1/2	—	44	\$5.48
64634	7/8	1/2	1/2	35	\$7.98
64636	1-1/8	1/2	—	28	\$8.90
64637	1-3/8	1/2	—	20	\$7.28
64638	1-5/8	1/2	—	15	\$9.90
64639	2-1/8	1/2	1-1/4	10	\$10.98
64640	2-5/8	1/2	—	10	\$14.54
64641	3-1/8	1/2	—	7	\$17.24

3/4 inch Wall

For OD size add 1-1/2 inch to inside diameter.

No.	ID	Wall	IPS	Ctn	Ea 6ft
64651	1/2	3/4	1/4	38	\$7.48
64652	5/8	3/4	3/8	28	\$8.12
64653	3/4	3/4	—	23	\$8.24
64654	7/8	3/4	1/2	20	\$10.82
64656	1-1/8	3/4	—	15	\$10.98
64657	1-3/8	3/4	—	12	\$15.94
64658	1-5/8	3/4	1-1/4	10	\$16.86
64659	2-1/8	3/4	—	9	\$22.66

Insulation Sheets 36 x 48 (12sf)

No.	Wall	Size	Ctn	Each
64691	3/8	36 x 48	16	\$27.16
64692	1/2	36 x 48	12	\$28.78
64693	3/4	36 x 48	9	\$43.40

Fittings

COPPER FITTINGS



**Tee Branch
End Smaller**

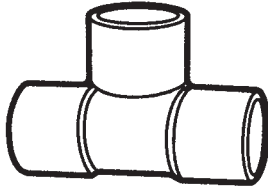

No.	Run OD Tube	Branch OD Tube	Each
11566	5/16"	1/4"	\$7.74
11502	3/8"	1/4"	\$8.86
11503	1/2"	1/4"	\$7.00
06330	1/2"	3/8"	\$7.00
06331	5/8"	3/8"	\$15.00
06332	5/8"	1/2"	\$15.00
06334	3/4"	3/8"	\$10.00
06340	3/4"	1/2"	\$25.52
06341	3/4"	5/8"	\$10.64
06335	7/8"	1/2"	\$3.00
06336	7/8"	5/8"	\$3.28
06342	7/8"	3/4"	\$2.48
06338	1-1/8"	5/8"	\$7.68
06343	1-1/8"	3/4"	\$11.32
06339	1-1/8"	7/8"	\$21.80
06350	1-3/8"	5/8"	\$11.28
06353	1-5/8"	5/8"	\$11.96

**Tee Branch
End Larger**

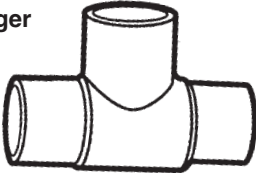

No.	OD Tube	OD Branch	Each
11354	1/4"	5/16"	\$6.00
11350	1/4"	3/8"	\$9.08
11353	3/8"	1/2"	\$8.88
11351	3/8"	5/8"	\$6.40
11405	1/2"	5/8"	\$5.84
06333	5/8"	7/8"	\$4.80
11407	7/8"	1-1/8"	\$8.32
11352	5/8"	1-1/8"	\$9.60

Tee

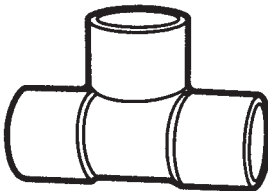

No.	OD Tube	Each
11599	3/16"	\$5.00
11565	5/16"	\$12.12
11511	1/4"	\$14.28
06323	3/8"	\$10.76
06325	1/2"	\$8.64
06326	5/8"	\$2.92
06327	3/4"	\$18.76
06328	7/8"	\$7.04
06329	1-1/8"	\$10.74
06376	1-3/8"	\$29.68
06377	1-5/8"	\$45.76

**Reducing
Coupling**

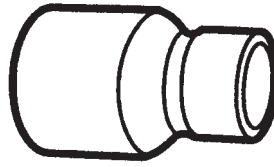

No.	OD Tube	OD Tube	Each
11562	1/4"	3/16"	\$4.40
11563	5/16"	1/4"	\$3.58
11508	3/8"	1/4"	\$8.44
11564	3/8"	5/16"	\$8.16
11509	1/2"	1/4"	\$3.72
06210	1/2"	3/8"	\$2.76
06204	5/8"	1/4"	\$1.08
06211	5/8"	3/8"	\$3.28
06212	5/8"	1/2"	\$2.72
06233	3/4"	3/8"	\$2.52
06213	3/4"	1/2"	\$8.16
06214	3/4"	5/8"	\$6.60
06240	7/8"	3/8"	\$1.92
06215	7/8"	1/2"	\$1.84
06216	7/8"	5/8"	\$4.60
06234	7/8"	3/4"	\$4.68
06217	1-1/8"	1/2"	\$3.52
06218	1-1/8"	5/8"	\$10.20
11548	1-1/8"	3/4"	\$9.12
06219	1-1/8"	7/8"	\$8.52
06220	1-3/8"	5/8"	\$12.44
06221	1-3/8"	7/8"	\$11.96
06222	1-3/8"	1-1/8"	\$11.96
06224	1-5/8"	5/8"	\$7.44
06235	1-5/8"	7/8"	\$18.28
06237	1-5/8"	1-1/8"	\$19.84
06238	1-5/8"	1-3/8"	\$19.84
06241	2-1/8"	5/8"	\$11.48
06242	2-1/8"	7/8"	\$11.04
06244	2-1/8"	1-1/8"	\$10.76
06245	2-1/8"	1-3/8"	\$10.76
06246	2-1/8"	1-5/8"	\$10.76

**Solder Adapter to Male Pipe;
Bushing**

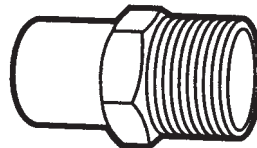

No.	Fits/Inside		Each
	OD Tube	Male IPT	
11568	1/4"	1/8"	\$8.04
11569	3/8"	1/4"	\$8.04
11570	1/2"	3/8"	\$5.70
11571	1/2"	1/2"	\$5.62
11572	5/8"	3/8"	\$12.80
11573	5/8"	1/2"	\$5.56
11574	7/8"	3/4"	\$15.28

Reducing Bushing

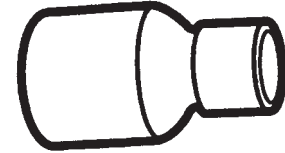

No.	Fits Inside		Each
	OD Tube	OD Tube	
11597	1/4"	1/8"	\$3.16
11448	3/8"	1/4"	\$3.64
11449	1/2"	1/4"	\$1.60
05920	1/2"	3/8"	\$3.76
05921	5/8"	3/8"	\$3.36
05922	5/8"	1/2"	\$3.04
05923	3/4"	3/8"	\$2.72
05924	3/4"	1/2"	\$7.40
05925	3/4"	5/8"	\$7.32
05926	7/8"	1/2"	\$6.04
05927	7/8"	5/8"	\$4.60
05928	7/8"	3/4"	\$4.68
05929	1-1/8"	1/2"	\$4.44
05930	1-1/8"	5/8"	\$9.24
11549	1-1/8"	3/4"	\$8.60
05931	1-1/8"	7/8"	\$7.08
05932	1-3/8"	5/8"	\$13.08
05933	1-3/8"	7/8"	\$13.08
05934	1-3/8"	1-1/8"	\$13.08
05935	1-5/8"	5/8"	\$6.04
05936	1-5/8"	7/8"	\$17.04
05937	1-5/8"	1-1/8"	\$17.04
05938	1-5/8"	1-3/8"	\$6.04
05939	2-1/8"	5/8"	\$12.00
05940	2-1/8"	7/8"	\$11.28
05941	2-1/8"	1-1/8"	\$11.92
05942	2-1/8"	1-3/8"	\$11.28
05943	2-1/8"	1-5/8"	\$16.32

**Solder Adapter
to Male Pipe**

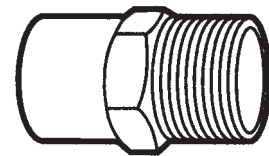

No.	OD Tube	Male IPT	Each
06303	1/2"	3/8"	\$8.64
06306	5/8"	3/8"	\$3.20
06307	5/8"	1/2"	\$3.56
06308	5/8"	3/4"	\$3.68
06360	5/8"	1"	\$3.20
06310	3/4"	1/2"	\$20.16
06311	3/4"	3/4"	\$13.24
06313	7/8"	1/2"	\$10.40
06314	7/8"	3/4"	\$6.00
06315	7/8"	1"	\$8.04
06317	1-1/8"	3/4"	\$8.04
06318	1-1/8"	1"	\$15.84
06319	1-1/8"	1-1/4"	\$3.54
06322	1-3/8"	1"	\$17.44
06362	1-3/8"	1-1/4"	\$22.92
06363	1-3/8"	1-1/2"	\$18.80
06367	1-5/8"	1-1/2"	\$9.24
BLPSMA-2	2"	2"	\$16.23

Fittings



Solder Elbow 90

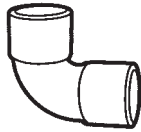

No.	OD Tube	Each
06223	3/8"	\$5.36
06225	1/2"	\$5.12
06226	5/8"	\$1.72
06227	3/4"	\$10.36
06228	7/8"	\$3.84
06229	1-1/8"	\$9.40
06248	1-3/8 "	\$14.20
06249	1-5/8"	\$22.12
06250	2-1/8"	\$29.56

Sold in Bags

No.	OD Tube	Bag Qty	Each
IMP06223	3/8"	25	\$18.54
IMP06226	5/8"	25	\$28.36
IMP06227	3/4"	25	\$79.94
IMP06228	7/8"	25	\$63.00

Solder Street Elbow 90

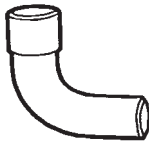

No.	OD Tube	Each
11445	1/4"	\$10.28
11446	3/8"	\$9.44
11451	1/2"	\$6.52
11452	5/8"	\$2.60
11440	3/4"	\$10.72
11567	7/8"	\$5.52
11591	1-1/8"	\$14.28
11592	1-3/8 "	\$21.64
11593	1-5/8"	\$28.36
11594	2-1/8"	\$21.68

Long Radius Elbow 90



No.	OD Tube	Each
11380	3/16"	\$11.12
11381	5/16"	\$8.62
11550	1/4"	\$10.08
11551	3/8"	\$7.24
11552	1/2"	\$9.12
11553	5/8"	\$7.76
11554	3/4"	\$7.84
11555	7/8"	\$10.04
11556	1-1/8"	\$16.16
11557	1-3/8 "	\$26.48
11558	1-5/8"	\$35.56
11559	2-1/8"	\$93.56

Sold in Bags

No.	OD Tube	Bag Qty	Each
IMP11551	3/8"	25	\$27.30
IMP11553	5/8"	25	\$53.62
IMP11554	3/4"	25	\$93.56
IMP11555	7/8"	10	\$51.86

Long Radius Street Elbow 90

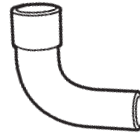

No.	OD Tube	Each
11450	3/8"	\$8.56
11499	1/2"	\$7.40
11590	5/8"	\$11.68
11453	3/4"	\$13.80
11454	7/8"	\$13.96
11455	1-1/8"	\$23.76
11456	1-3/8 "	\$35.08
11458	2-1/8"	\$70.44

Sold in Bags

No.	OD Tube	Bag Qty	Each
IMP11450	3/8"	25	\$30.22
IMP11590	5/8"	25	\$101.38
IMP11453	3/4"	25	\$64.32
IMP11454	7/8"	10	\$57.70

Reducing Elbow 90

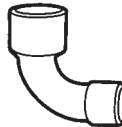

No.	OD Tube	OD Tube	Each
11504	3/8"	1/4"	\$4.28
06230	1/2"	3/8"	\$4.52
06231	5/8"	3/8"	\$5.00
06271	5/8"	1/2"	\$5.00
06232	5/8"LR	1/2"LR	\$21.40
06256	3/4"	1/2"	\$3.84
06255	3/4"	5/8"	\$12.80
06258	7/8"	1/2"	\$4.36
06236	7/8"	5/8"	\$7.92
06257	7/8"	3/4"	\$7.28
06260	1-1/8"	1/2"	\$7.36
06252	1-1/8"	5/8"	\$17.12
06259	1-1/8"	3/4"	\$7.24
06239	1-1/8"	7/8"	\$18.16
06261	1-3/8 "	1-1/8"	\$13.96
06269	1-3/8 "	1-1/8"	\$20.58
11598	1-5/8"	1-3/8 "	\$22.36

Street Elbow 45



No.	OD Tube	Each
06243	3/8"	\$14.28
06263	1/2"	\$11.20
06247	5/8"	\$3.72
06251	3/4"	\$23.60
06253	7/8"	\$5.52
06254	1-1/8"	\$18.16
06262	1-3/8 "	\$22.92
06270	1-5/8"	\$28.04

Solder Elbow 45

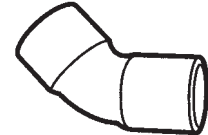

No.	OD Tube	Each
11410	1/4"	\$12.84
11411	3/8"	\$9.60
11412	1/2"	\$8.20
11413	5/8"	\$3.12
11414	3/4"	\$15.64
11415	7/8"	\$5.48
11416	1-1/8"	\$13.76
11417	1-3/8 "	\$18.64
11418	1-5/8"	\$22.44
11419	2-1/8"	\$13.16

Solder Coupling

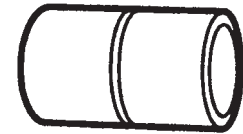

No.	OD Tube	Each
11400	1/8"	\$1.40
11462	3/16"	\$1.64
11514	5/16"	\$1.58
11447	1/4"	\$1.52
06203	3/8"	\$1.24
06205	1/2"	\$1.64
06206	5/8"	\$1.28
06207	3/4"	\$3.72
06208	7/8"	\$2.60
06209	1-1/8"	\$5.24
06200	1-3/8 "	\$8.86
06201	1-5/8"	\$12.16
06202	2-1/8"	\$20.32

Sold in Bags

No.	OD Tube	Bag Qty	Each
IMP06203	3/8"	25	\$14.60
IMP06206	5/8"	25	\$21.86
IMP06207	3/4"	25	\$38.00
IMP06208	7/8"	25	\$43.32

Solder Tube Caps



No.	OD Tube	Each
11580	1/4"	\$0.92
11581	3/8"	\$1.56
11582	1/2"	\$2.48
11583	5/8"	\$1.24
11584	3/4"	\$2.96
11585	7/8"	\$2.32
11586	1-1/8"	\$1.84
11587	1-3/8 "	\$7.32
11588	1-5/8"	\$10.76
11589	2-1/8"	\$6.96

Fittings

FITTINGS



Hot Water Connector

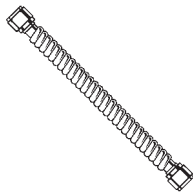

No.	Description	Each
CON5092112	12" Connector	\$19.24
CON5092118	18" Connector	\$15.68
CON5092124	24" Connector	\$26.28

Solder Union

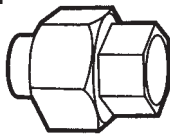

No.	OD Tube	Each
11487	5/8"	\$6.94
11488	7/8"	\$8.67

Solder Adapter to Female Pipe

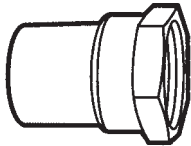

No.	OD Tube	Female IPT	Each
06280	3/8"	1/4"	\$4.08
06289	3/8"	3/8"	\$3.52
06282	1/2"	1/4"	\$3.60
06283	1/2"	3/8"	\$4.20
06284	1/2"	1/2"	\$12.32
06286	5/8"	3/8"	\$3.12
06287	5/8"	1/2"	\$5.68
06288	5/8"	3/4"	\$9.24
06279	3/4"	3/4"	\$4.72
06293	7/8"	1/2"	\$4.36
06294	7/8"	3/4"	\$7.80
06295	7/8"	1"	\$9.24
06297	1-1/8"	3/4"	\$9.24
06298	1-1/8"	1"	\$22.16

Solder Adapter to Female Pipe; Fitting Adapter Bushing

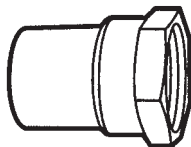

No.	OD Fitting	Female IPT	Each
11576	1/2"	3/8"	\$5.20
11577	5/8"	1/2"	\$9.52
11578	7/8"	3/4"	\$14.44
11579	1-1/8"	1"	\$9.16

Ball Valve Threaded

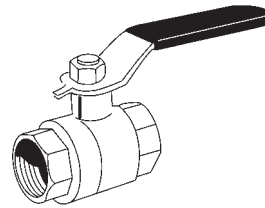

No.	ID Tube	Each
BVLV12TH	1/2"	\$13.08
BVLV34TH	3/4"	\$21.18
BVLV11TH	1"	\$27.56
BVLV114TH	1-1/4"	\$44.90

Ball Valve Sweat

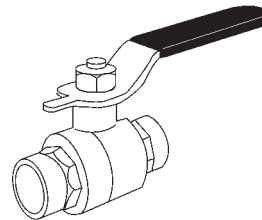

No.	OD Tube	ID Tube	Each
BVLV12SW	5/8"	1/2"	\$11.66
BVLV34SW	7/8"	3/4"	\$18.90
BVLV1SW	1-1/8"	1"	\$25.36
BVLV114SW	1-3/8"	1-1/4"	\$44.14
BVLV112SW	1-5/8"	1-1/2"	\$63.66

Return U-Bend



No.	OD Tube	Center	Each
11397	3/8"	1-1/2"	\$2.32
11471	1/2"	1-1/2"	\$4.48
11477	5/8"	2-1/8"	\$5.98
11398	5/8"	2-1/2"	\$11.44
11399	3/4"	2-1/8"	\$22.12
11482	3/4"	2-1/4"	\$10.24
11396	7/8"	2-1/2"	\$8.52

P-Trap

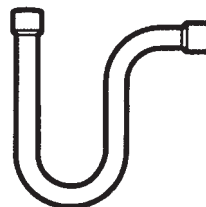

No.	OD Tube	Each
11347	7/8"	\$57.24
11348	1-1/8"	\$87.00
11349	1-3/8"	\$145.92

Heat Barrier Spray



Protects Heat Sensitive Components during soldering, brazing, or welding

- No drip formula
- Non Corrosive
- Non Toxic
- No Clean up
- Non Staining

No.	Description	Each
64461	32 oz Spray	\$42.50

Dielectric Union

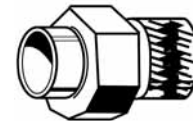

No.	Description	Each
BLPDU34	3/4" Dielectric Union	\$7.12
BLPDU1	1" Dielectric Union	\$8.90

Copper Pipe Strap



No.	OD Tube	Each
06437	3/8"	\$0.34
06438	1/2"	\$0.84
06440	5/8"	\$0.88
06441	7/8"	\$1.48
06442	1-1/8"	\$0.56
06443	1-3/8"	\$1.96
06444	1-5/8"	\$2.28
06445	2-1/8"	\$1.30

Perforated Pipe Strap

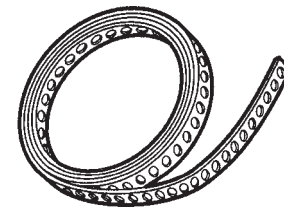

No.	Feet	Wide	Each
00660	25 ft	3/4"	\$25.60

Fittings



Pressure Relief Valve

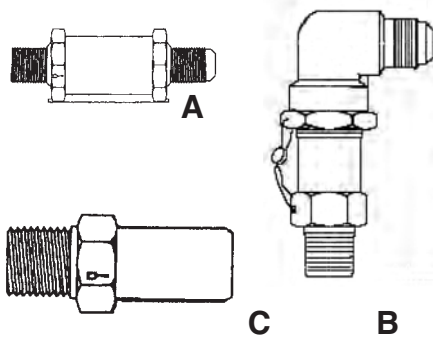

Pressure relief valves have been designed to provide high volume discharge. Pressure relief valves fully satisfy ASHRAE Standard 15 code requirements for a refrigerant vessel safety device. They comply with the ASME code for unfired pressure vessels and the discharge rates are certified by the National Board of Boiler and Pressure Vessels Inspectors.

Note: The relief valve setting should be at least 25% higher than maximum system operating pressure.

Pressure relief valves are designed primarily for use on liquid receiver applications, above the liquid refrigerant level, and it is recommended that the factory be consulted before the valves be used on other applications.

See MFG. Chart for selection.

No.	Type	Inlet Type	Outlet SAE	Press. Relief	Each
18500	A	1/4"	3/8"	235 lb.	\$89.04
18581	A	1/4"	3/8"	350 lb.	\$89.74
61453	A	1/4"	3/8"	400 lb.	\$137.32
61641	A	1/4"	3/8"	450 lb.	\$141.20
18509	A	3/8"	3/8"	235 lb.	\$91.02
18582	A	3/8"	3/8"	350 lb.	\$131.44
61454	A	3/8"	3/8"	400 lb.	\$144.20
61642	A	3/8"	3/8"	450 lb.	\$144.20
61455	A	3/8"	1/2"	400 lb.	\$84.62
61644	A	3/8"	1/2"	450 lb.	\$125.00
18592	A	1/2"	5/8"	235 lb.	\$164.28
18584	A	1/2"	5/8"	350 lb.	\$164.28
61645	A	1/2"	5/8"	450 lb.	\$182.36
61457	A	3/4"	3/4"	400 lb.	\$150.54
61649	A	3/4"	3/4"	450 lb.	\$261.16
61651	B	1"	1"	450 lb.	\$146.94
18593	B	1/4"	3/8"	235 lb.	\$99.04
18587	B	1/4"	3/8"	350 lb.	\$91.12
18594	B	3/8"	3/8"	235 lb.	\$99.04
18588	B	3/8"	3/8"	350 lb.	\$99.04
18597	B	3/8"	3/8"	450 lb.	\$99.04
61659	B	1/2"	5/8"	350 lb.	\$114.90
61660	B	1/2"	5/8"	425 lb.	\$96.16
18595	C	1/8"	No	235 lb.	\$75.28
18590	C	1/8"	No	350 lb.	\$75.28
18596	C	1/4"	No	235 lb.	\$75.28
61639	C	1/4"	No	425 lb.	\$68.66
18599	C	3/8"	No	235 lb.	\$71.32
61640	C	3/8"	No	425 lb.	\$103.62
18591	C	1/4"	No	350 lb.	\$75.28
18598	C	1/4"	No	450 lb.	\$75.28

Standard Pressure Gauges

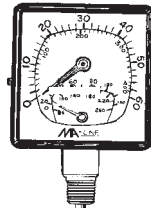

2" Case with Bottom Connection

No.	Pipe Thread	Reading	Each
08711	1/4" NPT	0-60 lbs.	\$20.86
08714	1/8" NPT	0-160 lbs.	\$20.86
08717	1/8" NPT	0-300 lbs.	\$20.86
08732	1/8" NPT	0-500 lbs.	\$56.48

Forged Brass Tee

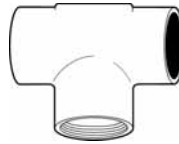

No.	Run	Branch	Each
15661	3/8" OD	3/8" FPT	\$63.24

Charged Line Adapter

This adapter can be soldered onto a charged line for installation of a gauge or relief valve. The adapter has a schraeder fitting to check system pressures.



No.	OD Tube	FPT	Each
21625	3/8"	1/4"	\$43.16
21626	1/2"	1/4"	\$48.62
21627	5/8"	3/8"	\$73.48

Diaphragm Packless Valves

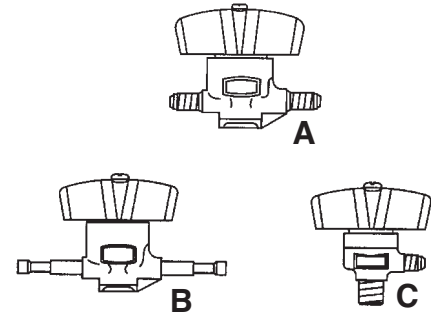

With forged brass bodies with wrench flats and integral mounting base. A phosphor bronze diaphragm between 2 stainless steel diaphragms makes a positive seal between the bonnet and tee body.

No.	Type	Size	High Full Open	Each
32140	A	1/4" SAE	3"	\$49.00
32141	A	3/8" SAE	3"	\$49.00
32142	A	1/2" SAE	3-5/8"	\$69.42
32143	A	5/8" SAE	3-5/8"	\$63.56

Have extended ends to allow a wet cloth to protect the valve when soldering to avoid disassembling.

No.	Type	Size	Roughing in Dimensions	Each
32148	B	1/4" OD	5-3/8"	\$63.56
32149	B	3/8" OD	5"	\$64.78
32150	B	1/2" OD	6-5/16"	\$73.52
32151	B	5/8" OD	6-5/16"	\$77.48

No.	Type	Bottom MIPT	Side Flare	Each
32152	C	1/4" MIPT	1/4" SAE	\$55.24
32153	C	1/4" MIPT	3/8" SAE	\$55.24
32154	C	3/8" MIPT	1/2" SAE	\$55.24
32158	C	1/2" MIPT	5/8" SAE	\$59.62

Angle Shut Off Valve

For liquid receivers, manifolds, evaporator heads, or for use as compressor valve. With seal cup.

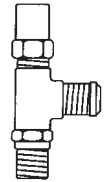

No.	Size	Each
03720	1/4" with 1/4" Male IPT	\$48.26
03724	3/8" with 3/8" Male IPT	\$36.50

Diaphragm Packless Valve

For liquid receivers, manifolds, evaporator heads, or for use as compressor valve. With seal cup.

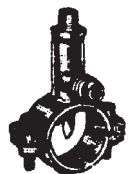

Branch Connection: 3/8" SAE

No.	Fits Iron Pipe	Fits Nom. Copper Tube	Each
60532	3/4" Nom.	1-3/8" OD	\$44.96
60533*	1/2" Nom.	7/8" OD	\$49.88

*Has insert to fit 5/8" OD Copper

Fittings

ACCESS FITTINGS

C&D Connectors

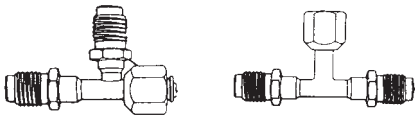

The end with 1/4" female flare has a depressor tip to depress and open a core on a sealed system, while one 1/4" male flare is attached to the control and the remaining 1/4" male flare has a core for access.

No.	1/4" Female Flare On	Pkg.	Each
60751	Run	2	\$9.28
60752	Branch	2	\$9.28

Access Fitting 90° Swivel Adapter Straight Union Adapter



No.	Description	Each
09351	1/8" Female IPT	\$16.94

Access Fitting / Quick Connect

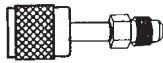

No.	Description	Each
49476	3/16 FMBT x 1/4 MSAE	\$28.42
27081	1/4 FSAE x MSAE Quick Connect	\$28.52

Copper Line Tap Valve

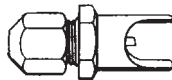

No.	Line Tap Valve	Pkg.	Each
60755	1/4" Tubing	6	\$6.48
60756	5/16" Tubing	6	\$6.48
60757	3/8" Tubing	6	\$6.50
60758	1/2" Tubing	4	\$7.36
60759	5/8" Tubing	3	\$8.44
60761	Replacement Gasket	25	\$0.50

Thumb Screw Core Depressor

1/4" male flare to allow core to be opened to the degree of flow desired.



No.	Description	Each
60754	Core Depressor	\$14.58
60760	Replacement Gasket (10)	\$0.62

Extra Schrader Cores



No.	Description	Each
60753	Cores with Plastic Holder and Tool	\$13.58
22795	6 Cores	\$5.32

Package Quantities listed -
Price is each - not package price.

Quick Cap



No.	Description	Pkg.	Each
22705	1/4" SAE Brass Cap	6	\$0.82

Vacuum/Charge Valve Core Re- placer Tool

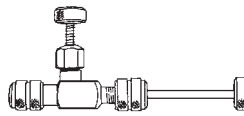

Save Time-Save Money. Attach this valve to the low side of the system and remove the Schrader without opening the system. Remove the valve opener in the charging hose. Now pull through unrestricted lines for maximum vacuum in the minimum time. Much faster than leaving Schrader valve opener in. Also functions as a core replacer.

No.	Description	Each
60750	CRT Tool	\$78.50
60748	Tool w/ Access Port	\$94.60

Charging Valve

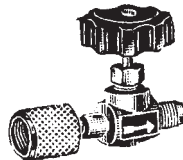

No.	Description	Each
21424	1/4" SAE Fem Coupler by 1/4" SAE Male Fitting	\$42.78

Access Fittings



No.	1/4" SAE Valve To	Pkg.	Each
22788	1/8" Male IPT	6	\$3.24
22789	1/4" Male IPT	6	\$3.66

Solder Fittings to 1/4" SAE Valve Packages of 6

No.	Fits Tube	Or Fits into Solder Fitting	Each
22792	3/16" OD	or 1/4" and 3/8"	\$2.82
22790	1/4" OD	or 3/8" Fitting	\$2.82

Solder Tee To 1/4" SAE Valve On Branch



No.	Description	Pkg.	Each
22793	1/4" OD On Run	2	\$5.44
22798	5/16" OD On Run	2	\$5.06
22794	3/8" OD On Run	2	\$6.04
60745	5/8" OD On Run	2	\$7.86
60746	3/4" OD On Run	2	\$9.04
60747	7/8" OD Run	2	\$9.04

Access Fitting with 2" Tube

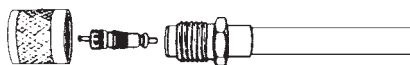

No.	With 2" Long Tube	Pkg.	Each
01549	1/8" OD	6	\$4.36
01550	3/16" OD	6	\$4.36
01551	1/4" OD	6	\$4.36
01552	3/8" OD	6	\$5.00

Liquid Low Side Charger



The Kwik charge takes liquid refrigerant from the container and changes saturated vapor into the low side of the system. The charging rate is eight times faster than vapor charging. A metering element keeps the liquid flow below the capacity of the compressor, 1/4" female SAE inlet 1/4" male SAE outlet.

No.	Description	Each
16380	Liquid Low Side Charger	\$60.78

"Bullet" Charge and Tap Valve

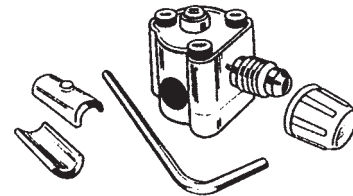

No.	Tube	Each
60502	5/16" OD	\$6.52
60508	3/4" OD	\$32.86
60509	7/8" OD	\$33.38
60514	One Size For 1/4", 5/16", 3/8" OD	\$5.00
60515	One Size For 1/2", 5/8" OD	\$5.82

Saddle Self Tapping Valve

Has brass body and spindle with stainless steel handle and piercing needle. For 3/8" to 1-1/8" OD copper tube with outlet 1/4" compression fitting. Clamp on tube and connect line, turn handle to pierce tube.

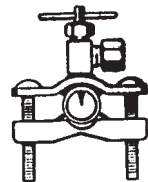

No.	Description	Each
P110-0001	Saddle Valve	\$28.08
STV2	Saddle Valve	\$4.26

Access Fitting Service Kit



Kit includes: Schrader removal tool, core depressor, access fittings, schraders, caps.

No.	Description	Each
22799	Access fitting service kit	\$103.58

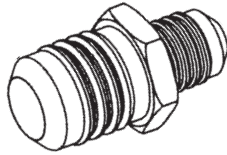
Brass Reducing Nipple

No.	IPT	Box Qty	Each
03876	1/4" X 1/8"	1	\$1.12

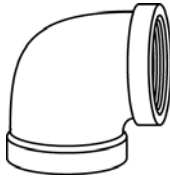
Brass Elbow

No.	IPT	Box Qty	Each
03641	1/4"	5	\$4.00
03642	3/8"	1	\$4.98
03643	1/2"	1	\$7.92

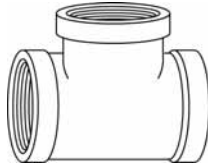
Brass Tee

No.	IPT	Box Qty	Each
03645	1/8"	1	\$5.08
03646	1/4"	1	\$3.74
03647	3/8"	1	\$6.40
03648	1/2"	1	\$9.78

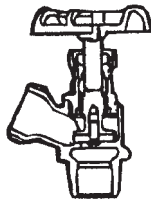
Boiler Drain Valve

No.	Nominal Size	Each
06424	1/2" Male IPT	\$7.54
06425	3/4" Male IPT	\$7.74

Ferrule Break Away Fitting

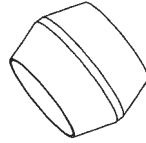

No.	Description	Each
73771	1/4" Break Away	\$3.96

Compression Sleeves

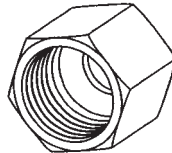
No.	Tube OD	Box Qty	Each
01009	1/8"	20	\$0.18
01001	1/4"	20	\$0.18
01003	3/8"	20	\$0.14
01005	1/2"	10	\$0.18

Compression Nut

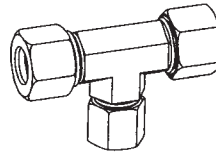
No.	Tube OD	Box Qty	Each
01019	1/8"	10	\$0.24
01021	1/4"	10	\$0.64
01023	3/8"	10	\$0.80
01025	1/2"	10	\$0.64

Compression Tee

No.	Tube OD	Box Qty	Each
01041	1/4"	1	\$3.38
01043	3/8"	1	\$8.18
01045	1/2"	1	\$6.76

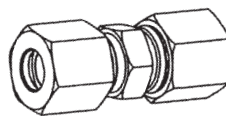
Compression Union

No.	Tube OD	Box Qty	Each
01029	1/8"	5	\$1.20
01031	1/4"	5	\$1.34
01033	3/8"	5	\$1.44
01035	1/2"	5	\$2.36

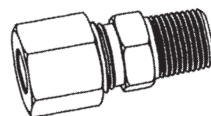
Compression Male Half Union

No.	Tube OD	IPT	Each
01050	1/8"	1/8"	\$1.12
01052	1/4"	1/8"	\$1.04
01053	1/4"	1/4"	\$1.26
01057	3/8"	1/4"	\$1.34
01058	3/8"	3/8"	\$3.12
01059	1/2"	3/8"	\$4.68

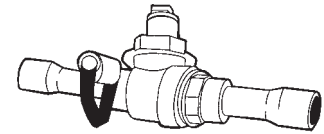
Shut-off Ball Valve

Forged brass body with copper pipes, silver soldered into the body. Need only 1/4" turn for on or off. Maximum operating pressure of 500 PSI. Reinforced Teflon seals for positive fitting and longer life. Chromium plated ball for smooth valve action. Dot on stem should be upstream when valve is in off position.

No.	Comm. Size ODF	Norm. Capacity of PSI Drop		Overall Length	Each
		R-12	R-22		
60730	3/8"	10	13	5-1/2"	\$61.86
60731	1/2"	24	30	6-3/8"	\$61.86
60732	5/8"	31	38	6-3/8"	\$67.02
60733	7/8"	72	88	7-7/16"	\$84.88
60734	1-1/8"	108	132	9-1/8"	\$122.48
60735	1-3/8"	224	274	10"	\$194.22
60736	1-5/8"	224	274	11"	\$216.68

Johnson Control V46

The V46 is a pressure actuated, modulating valve that is suitable for use either on closed or open systems. This type of valve is primarily used to regulate the flow of water or glycol to a water cooled condenser on a refrigeration system.

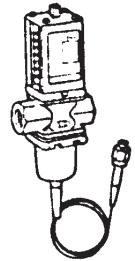

No.	Johnson No.	FIPT	Each
20921	V46AA-1	3/8"	\$206.30
20922	V46AB-1	1/2"	\$210.08

Adjustable Clamp

No.	Description	Each
FLSH3858	3/8"to5/8 Adjustable clamp	\$1.10

Boiler Gauges

Pressure and Temperature Gauge

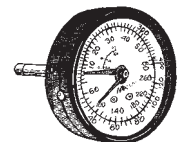

No.	Size	NPT	Each
08736	2-1/2"	1/4"	\$34.92
309433-211	2-1/2"	1/4"	\$363.04

BRASS PIPE | FLARE FITTINGS



Flare Nuts



A Long Forged Nuts SAE Flare

No.	Tube Size	Box Quantity	Each
03301	1/4"	20	\$3.34
03303	3/8"	10	\$2.58
03305	1/2"	5	\$5.30
03306	5/8"	2	\$15.08

A Reducing Long Forged Nuts SAE Flare

No.	Fitting Size	Tube Size	Box Quantity	Each
03581	3/8"	1/4"	2	\$2.68

B Short Forged Nuts SAE Flare

No.	Tube Size	Box Quantity	Each
03311	1/4"	20	\$2.28
03312	5/16"	10	\$1.84
03313	3/8"	10	\$2.98
03315	1/2"	10	\$4.46
03316	5/8"	5	\$5.52
03317	3/4"	5	\$9.92

B Reducing Short Forged Nuts SAE Flare

No.	Fitting Size	Tube Size	Box Quantity	Each
04501	3/8"	1/4"	5	\$2.82
04505	1/2"	3/8"	5	\$4.50
04507	5/8"	1/2"	5	\$4.08

Imperial Half Union

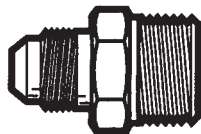

Half Union SAE Flare to Male Pipe Thread

No.	SAE	IPT	Box Qty	Each
03401	1/4"	1/8"	20	\$2.28
03402	1/4"	1/4"	10	\$2.40
03403	1/4"	3/8"	5	\$2.80
05400	1/4"	1/2"	5	\$3.24
03409	3/8"	3/8"	10	\$2.80
05401	3/8"	1/2"	5	\$3.32
03411	1/2"	1/4"	5	\$8.24
03412	1/2"	3/8"	5	\$3.44
03413	1/2"	1/2"	5	\$4.14
05404	1/2"	3/4"	2	\$8.86
05405	5/8"	1/4"	2	\$6.20
03415	5/8"	1/2"	2	\$4.76

Brass Union Reducer SAE Flare

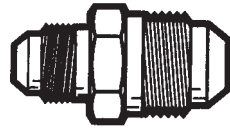

No.	Tube	Size	Box Quantity	Each
03519	1/4"	3/16"	10	\$4.48
03520	5/16"	1/4"	5	\$6.50
03521	3/8"	1/4"	5	\$2.94

Brass Union SAE Flare

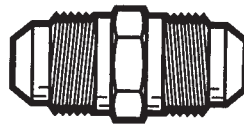

No.	Size	Box Quantity	Each
03330	3/16"	5	\$4.86
03331	1/4"	10	\$2.00
03333	3/8"	10	\$2.40
03335	1/2"	5	\$2.76
03337	3/4"	2	\$12.72

Half Union SAE Flare to Female Pipe Thread

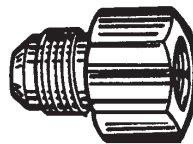

No.	SAE	FIPT	Box Quantity	Each
03481	1/4"	1/8"	10	\$1.96
03482	1/4"	1/4"	5	\$2.50
03488	3/8"	1/4"	10	\$2.50
03489	3/8"	3/8"	10	\$6.94
03491	1/2"	1/4"	5	\$7.08

Half Union Female SAE Flare to Male Pipe Thread

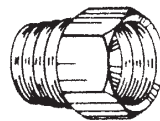

No.	SAE	FIPT	Box Quantity	Each
04261	1/4"	1/8"	10	\$6.74

Brass Coupling

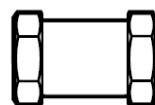

No.	IPT	Box Quantity	Each
03655	5/16"	5	\$0.94
03656	3/8"	5	\$1.70
03657	1/2"	1	\$1.96
03658	5/8"	1	\$3.52

Brass Solder Adapter To Female Pipe

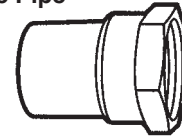

No.	OD Tube	Female IPT	Each
BLPSFA-34	3/4"	3/4"	\$1.70

Brass Adapter

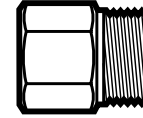

No.	Fem.	Male	Box Quantity	Each
03890	1/4"	1/8"	5	\$1.38
03891	3/8"	1/4"	1	\$2.32
03892	1/2"	3/8"	1	\$3.88

Both Ends Female



No.	FIPT	Box Quantity	Each
03894	1/4" x 1/8"	1	\$1.70
03895	3/8" x 1/4"	1	\$2.68
03896	1/2" x 3/8"	1	\$3.92

Brass Plugs



No.	IPT	Box Quantity	Each
03870	1/8"	5	\$0.94
03871	1/4"	5	\$1.48
03872	3/8"	5	\$4.50
03873	1/2"	1	\$1.74
03886	3/4"	1	\$7.30

Brass Reducing Bushing



No.	MPT	FIPT	Box Quantity	Each
03880	1/4"	1/8"	5	\$0.76
03881	3/8"	1/4"	5	\$7.30
03882	3/8"	1/8"	5	\$0.98
03883	1/2"	3/8"	1	\$7.60
03884	1/2"	1/4"	1	\$7.60
03897	3/4"	1/2"	1	\$7.60

Brass Hexagon Nipple

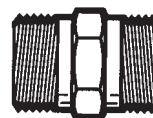

No.	IPT	Box Quantity	Each
03874	1/8"	5	\$0.72
03875	1/4"	5	\$0.94
03879	1/2"	1	\$2.46

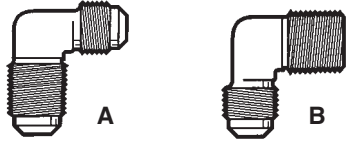

A Forged Brass Elbow SAE Flare

No.	SAE	Box Quantity	Each
03361	1/4"	10	\$4.80
03363	3/8"	10	\$6.76

B Hold Elbow SAE Flare to Male Pipe Thread

No.	SAE	IPT	Box Quantity	Each
03421	1/4"	1/8"	20	\$4.68
03422	1/4"	1/4"	10	\$5.34
03423	1/4"	3/8"	5	\$6.72
03428	3/8"	1/4"	10	\$4.60
03429	3/8"	3/8"	10	\$5.82
05421	3/8"	1/2"	5	\$10.28
03435	5/8"	1/2"	5	\$16.58

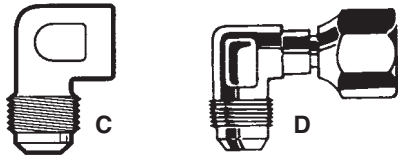

C Half Elbow SAE Flare to Female Pipe Thread

No.	SAE	FPT	Box Quantity	Each
03502	1/4"	1/4"	5	\$14.14
03508	3/8"	1/4"	5	\$11.66
03509	3/8"	3/8"	5	\$12.40
03512	1/2"	3/8"	5	\$3.96
03513	1/2"	1/2"	5	\$23.38

D Imperial Swivel SAE Nut to SAE Elbow

Used to make connections on condensers when a sharp 90 deg bend is required. Will help in many installations and service problems.

No.	Size	Box Quantity	Each
04205	3/8"	2	\$12.16
04206	1/2"	2	\$18.82
04207	5/8"	2	\$22.08



E 1/4" Female SAE to Female IPT

No.	Female	Box Quantity	Each
03371	1/4"	5	\$4.24
03373	3/8"	5	\$8.28

F Manifold Union Coupling with Female SAE Flare Both Ends

No.	Female	Box Quantity	Each
03591	1/4"	10	\$7.04
03593	3/8"	10	\$4.14
03595	1/2"	10	\$12.40
03596	5/8"	5	\$9.48



G Forged Reducer SAE Flare Female End Larger

No.	Female	Male	Box Quantity	Each
03561	3/8"	1/4"	10	\$3.92
03565	1/2"	3/8"	5	\$5.74

H Forged Reducer SAE Flare Male End Larger

No.	Female	Male	Box Quantity	Each
03571	1/4"	3/8"	5	\$4.40
03575	3/8"	1/2"	5	\$2.94
03577	1/2"	5/8"	5	\$6.00

Imperial Half Union SAE to OD Solder

A very handy fitting that saves time and trouble when making connection tubing that is to short and not suitable for flaring.

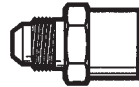

No.	SAE	OD	Box Quantity	Each
04200	1/4"	1/4"	5	\$0.90
04201	1/4"	3/8"	5	\$6.20
04202	3/8"	3/8"	5	\$1.90

Imperial Swivel Nut to OD Solder

When replacing or adding an SAE cencydrator or strain in a line you can use these fittings to do a better job that will save you time and money.



No.	OD	Each
04208	1/4"	\$6.94
04209	3/8"	\$7.24
04210	1/2"	\$8.12
04211	5/8"	\$7.32

Copper Seal Cap for SAE Flare Fittings



No.	SAE	Box Quantity	Each
03601	1/4"	20	\$1.12
03603	3/8"	20	\$0.80
03605	1/2"	20	\$1.08
03606	5/8"	20	\$1.44

Copper Flare Gaskets



No.	SAE	Box Quantity	Each
16970	1/4"	50	\$0.64
16971	3/8"	50	\$0.74
16972	1/2"	25	\$0.80
16973	5/8"	25	\$0.86
16974	3/4"	10	\$1.00

FLARE FITTINGS



I Forged Tee SAE Flare

No.	Female	Box Quantity	Each
03341	1/4"	10	\$4.36
03343	3/8"	5	\$5.96

J Forged Reducer SAE Flare Female End Larger

No.	Female	Male	Box Quantity	Each
03462	1/4"	1/4"	5	\$7.60
03468	3/8"	1/4"	5	\$6.98
03469	3/8"	3/8"	5	\$7.48
03472	1/2"	3/8"	5	\$12.76
03473	1/2"	1/2"	5	\$15.44

Brass Flare Cap



No.	SAE	Box Quantity	Each
03391	1/4"	5	\$0.98
03393	3/8"	5	\$2.14
03395	1/2"	5	\$1.78
03396	5/8"	5	\$4.36
03397	3/4"	5	\$4.82

Cylinder Connections

A brass machined cylinder connection with gaskets for connecting tubing to refrigerant cylinder.

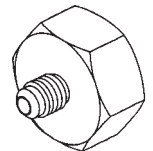

- 1/2" FIPT for 10 to 35 lb cylinders or CO2 tanks
- 3/4" FIPT for 150 lb. cylinders

No.	FIPT	Male SAE	Each
05638	1/2"	1/4"	\$23.04
05639	3/4"	1/4"	\$8.70
05664	3/4"	3/8"	\$14.16

Gaskets

No.	Size	Used on	Each
05666	1/2"	05638	\$0.28
05667	3/4"	05639, 05664	\$0.44

Fusible Plug

Relieves high pressures caused by excessive heat by melting the fusible metal in the plug. Fusible metal melts at 168 deg F



Approved Safety Plugs

No.	IPT	Each
03887	1/8"	\$6.94
03888	1/4"	\$9.16
03889	3/8"	\$8.12

Fittings